



Technical Data

Specification & Capacities



SPX424

S.N: _____



CP: 14,9kW/20Hp



C+: 4,0kW/5,5Hp



2,6-8,5m



2400kg



Via Campardone, 7
31014 Colle Umberto – Italy
Tel. +39 0438 434443
Mail: info@jekko.it
Web: www.jekko.it

Date	06-2014
REV.	DRAFT

SPX424 - OVERALL DIMENSIONS

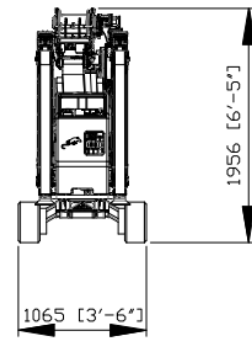
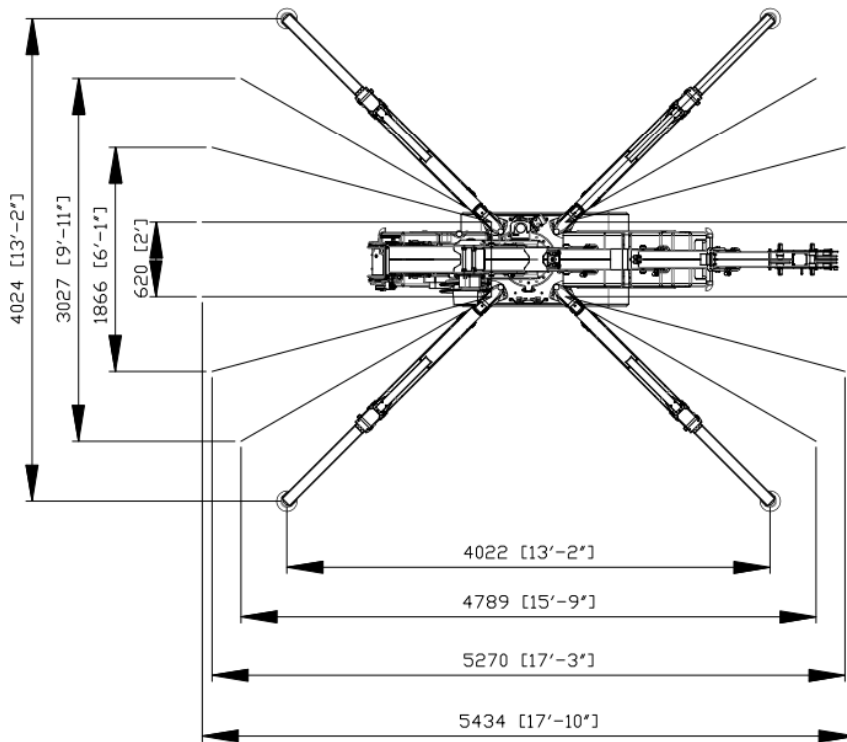
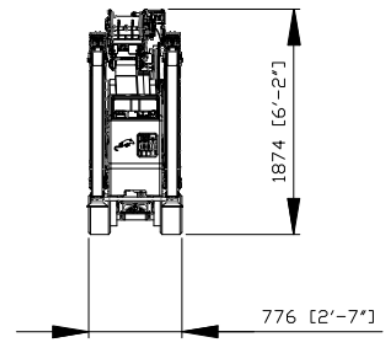
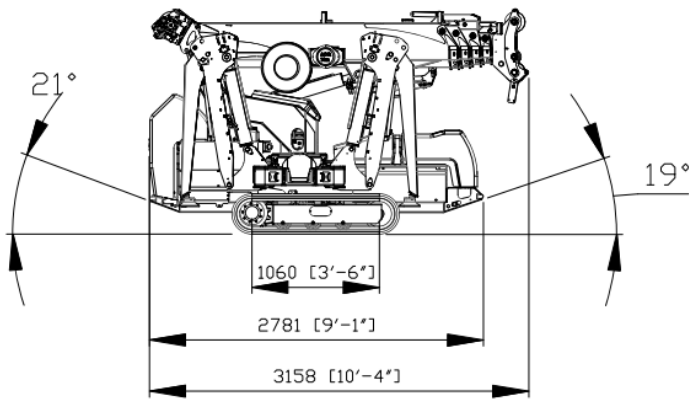

		kg	lbs
		2170	4774
		200	440
Tot.		2370	5214

	KUBOTA D722-E3B	kW	14,9kW 20Hp		
			GASOLINE		
			l	6	
			gal	1,59	
	n°4 6V 240Ah	kW	24V-3F 4,0kW 5,5Hp		

	km/h	1,8
	mph	1,1
	20°	
	kg/cm ²	0,55
	lbs/ftq	1124
	kg	2700
	lbs	5940

	0°/75°		14"
	360°		1,5 rpm
	m	2,6-8,5	26"
	ft	8'6"-27'11"	

HOIST PERFORMANCE

Layer	Max Line Pull		Normal Line Speed		High Line Speed	
	kg	Lbs	m/min	ft/min	m/min	ft/min
1	1000 (*)	2.200 (*)	21	67.0	25.7	84.3
2	930 (*)	2.050 (*)	22.5	73.8	28.0	91.8
3	860 (*)	1.890 (*)	24.5	80.4	29.5	96.8
4	800	1.760	26	85.3	31.8	104.0

(*) LMI limited at 800 [kg] (1760 lbs)

Wire Rope	Diameter		Tot. Length		Max Load	
	mm	in	m	ft	kg	lbs
A4 ALC	7	1/4"	70	229	4.970	10.930

HOOK BLOCK

LOAD		No. of	
kg	lbs	Sheaves	Lines
2400	5280	1	3
1600	3520	1	2
800	1760		1

SPX424

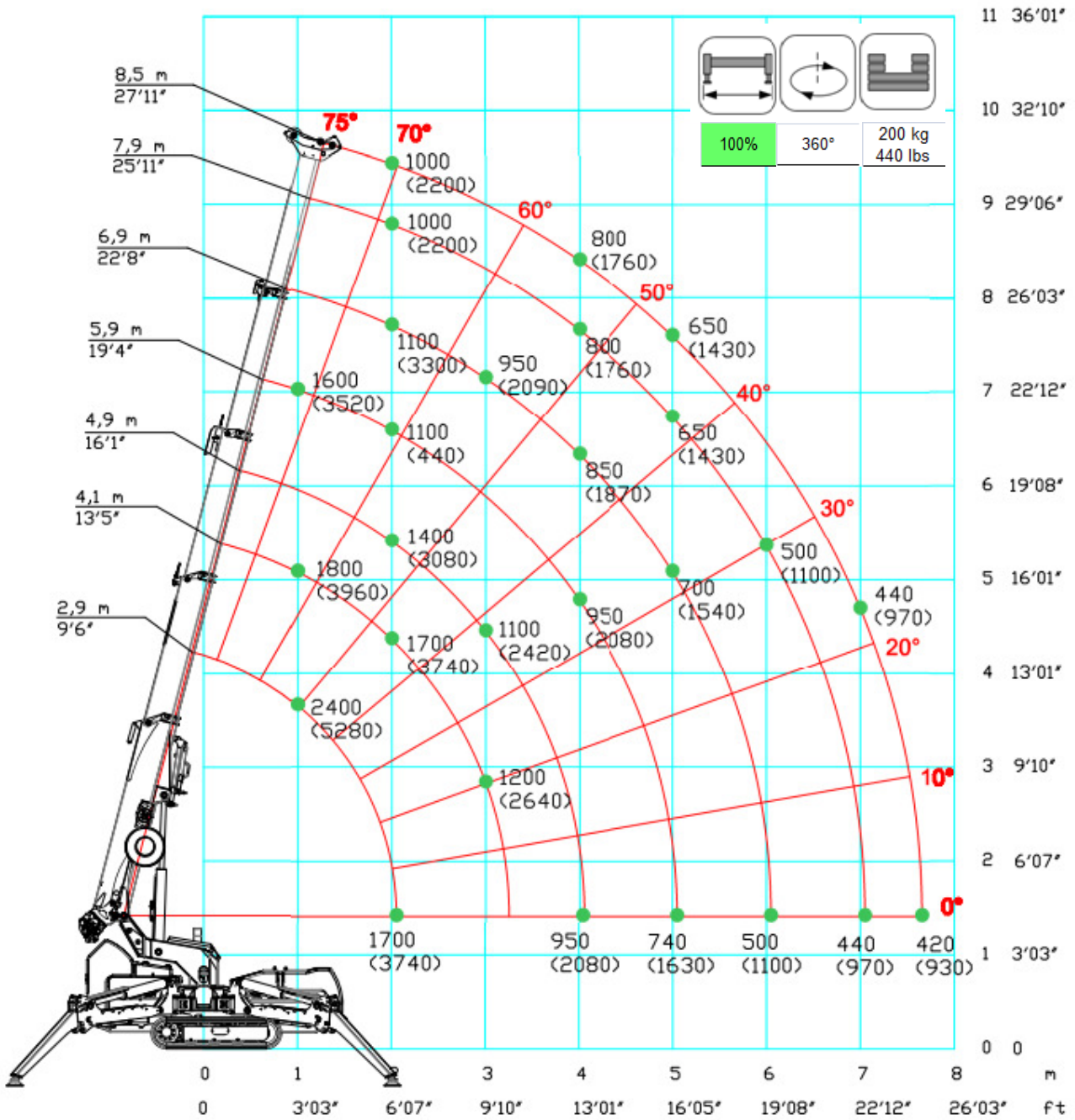

		100%	360°	200 kg 440 lbs			
	2,9	4,1	4,9	5,9	6,9	7,9	8,5
	9,51	13,45	16,08	19,36	22,64	25,92	27,89
1,0	2400	1800	1700	1600	1500	1450	1450
3,28	5280	3960	3740	3520	3300	3190	3190
2,0	1700	1700	1400	1100	1100	1000	1000
6,56	3740	3740	3080	2420	2420	2200	2200
3,0		1200	1100	1000	950	900	900
9,84		2640	2420	2200	2090	1980	1980
4,0			950	950	850	800	800
13,12			2090	2090	1870	1760	1760
5,0				740	700	650	650
16,40				1628	1540	1430	1430
6,0					500	500	500
19,69					1100	1100	1100
7,0						440	440
22,97						968	968
7,6							420
24,93							924

kg/m

lbs/ft

		50%	360°	200 kg 440 lbs			
	2,9	4,1	4,9	5,9	6,9	7,9	8,5
	9,51	13,45	16,08	19,36	22,64	25,92	27,89
1,0							
3,28							
2,0							
6,56							
3,0							
9,84							
4,0							
13,12							
5,0							
16,40							
6,0							
19,69							
7,0							
22,97							
7,6							
24,93							

SPX424 + JIB800GX

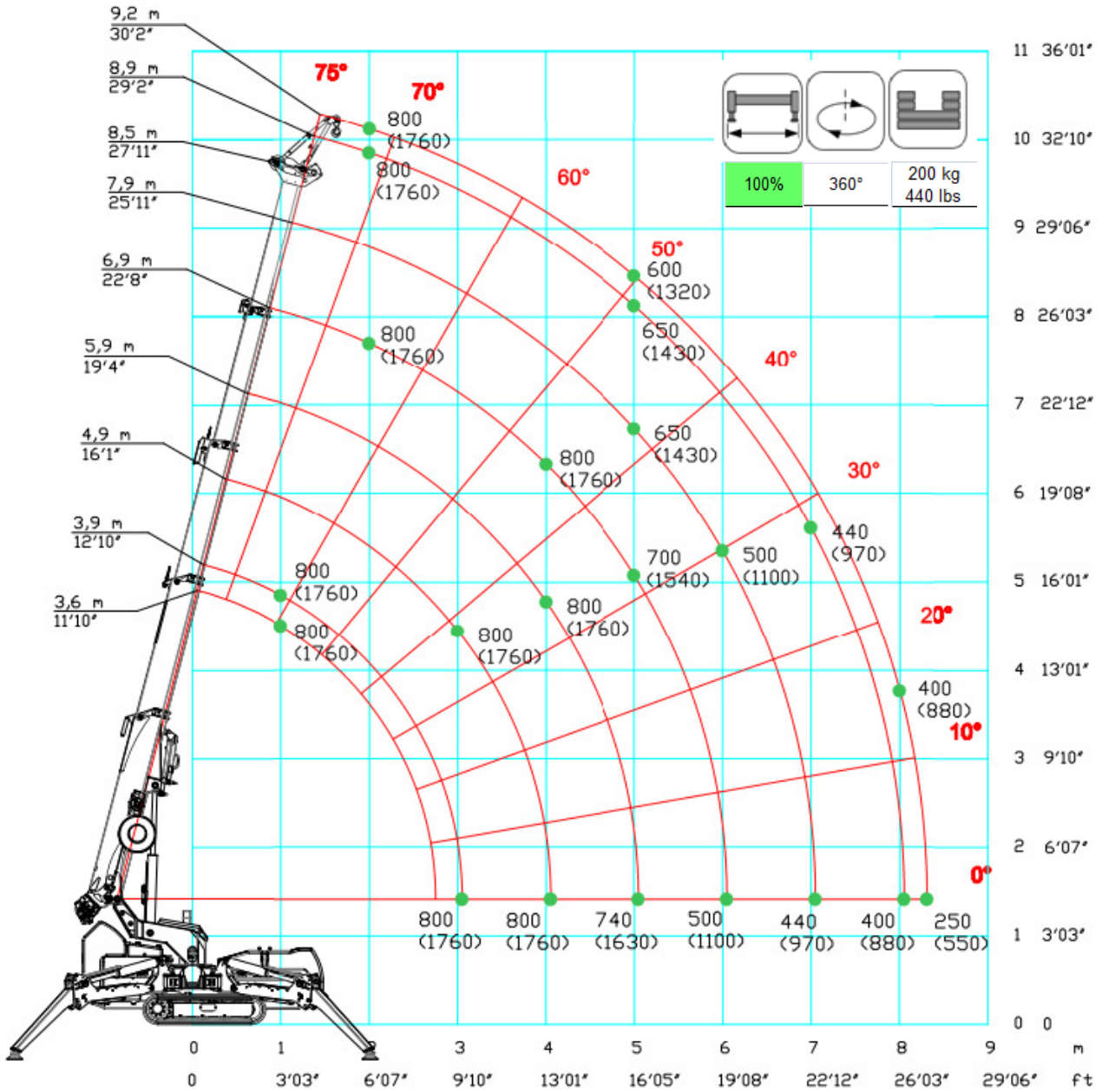

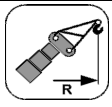
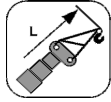
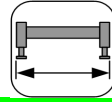
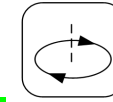
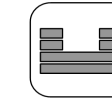
	   											
	JIB800GX	100%	360°	200 kg 440 lbs	3,6	3,9	4,9	5,9	6,9	7,9	8,9	9,2
	11,81	12,80	16,08	19,36	22,64	25,92	29,20	30,18				
1,0	800	800	800	800	800	800	800	800	800	800	800	800
3,28	1760	1760	1760	1760	1760	1760	1760	1760	1760	1760	1760	1760
2,0	800	800	800	800	800	800	800	800	800	800	800	800
6,56	1760	1760	1760	1760	1760	1760	1760	1760	1760	1760	1760	1760
3,0		800	800	800	800	800	800	800	800	800	800	800
9,84		1760	1760	1760	1760	1760	1760	1760	1760	1760	1760	1760
4,0			800	800	800	800	800	800	800	800	800	800
13,12			1760	1760	1760	1760	1760	1760	1760	1760	1760	1760
5,0				740	700	650	650	600				
16,40				1628	1540	1430	1430	1320				
6,0					500	500	500	450				
19,69					1100	1100	1100	990				
7,0						440	440	400				
22,97						968	968	880				
8,0							400	400				
26,25							880	880				
8,3								250				
27,23								550				

kg/m

lbs/ft

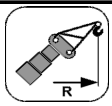
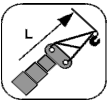
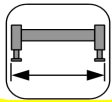
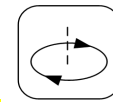
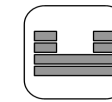
	   											
	JIB800GX	50%	360°	200 kg 440 lbs	3,6	3,9	4,9	5,9	6,9	7,9	8,9	9,2
	11,81	12,80	16,08	19,36	22,64	25,92	29,20	30,18				
1,0												
3,28												
2,0												
6,56												
3,0												
9,84												
4,0												
13,12												
5,0												
16,40												
6,0												
19,69												
7,0												
22,97												
8,0												
26,25												
8,3												
27,23												

SPX424 + JIB800.1HX

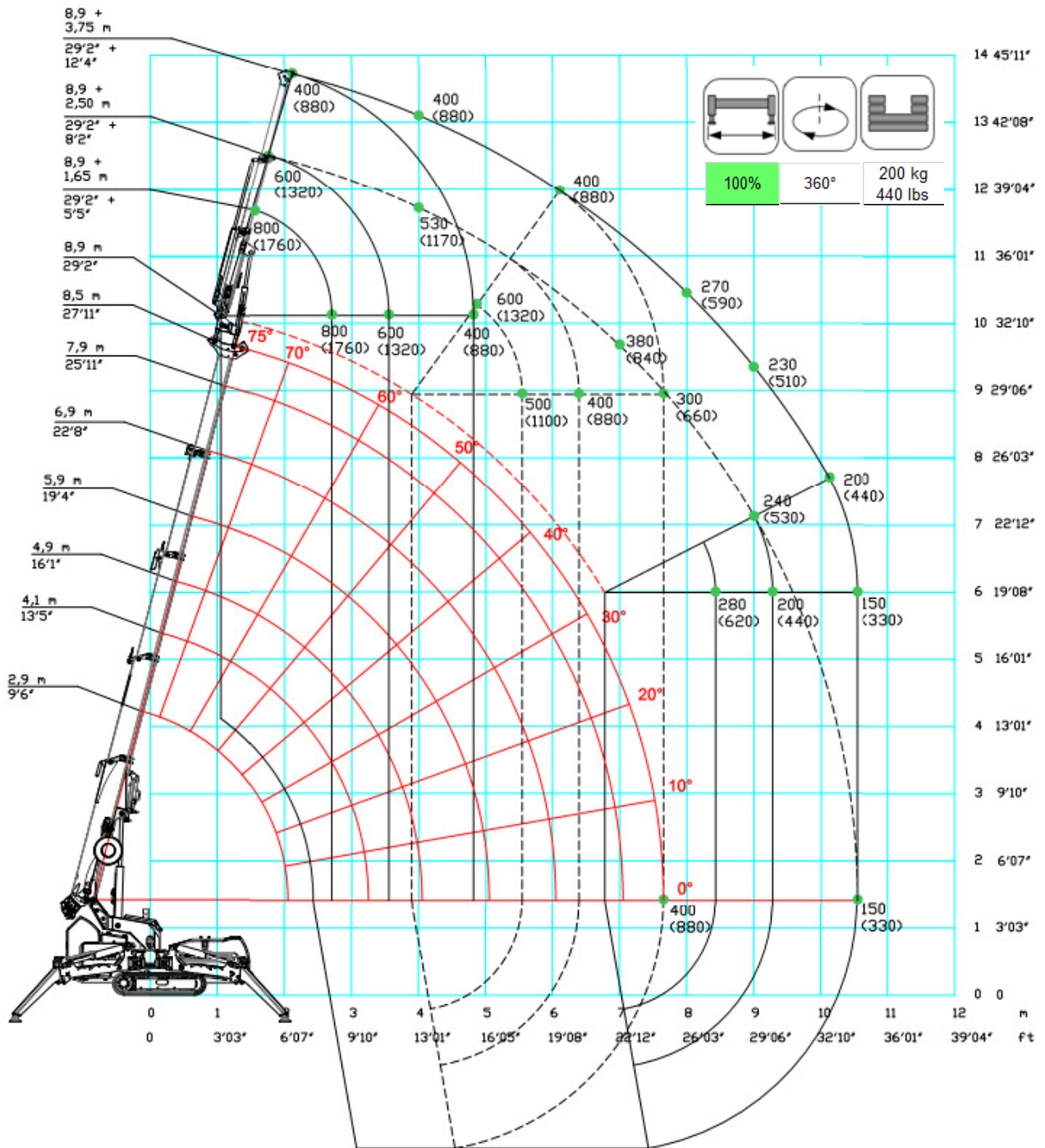

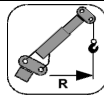
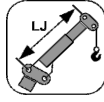
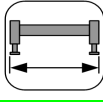
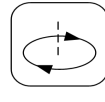
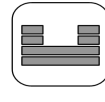
				
	JIB800.1HX	100%	360°	200 kg 440 lbs
	1,65	2,5	3,75	
	5,41	8,20	12,30	
2,0	800	600	400	
6,56	1760	1320	880	
3,0	700	570	400	
9,84	1540	1254	880	
4,0	600	530	400	
13,12	1320	1166	880	
5,0	600	500	400	
16,40	1320	1100	880	
6,0	480	450	400	
19,69	1056	990	880	
7,0	440	380	350	
22,97	968	836	770	
8,0	320	300	270	
26,25	704	660	594	
9,0		240	230	
29,53		528	506	
10,0			200	
32,81			440	
10,6			150	
34,78			330	

kg/m
lbs/ft

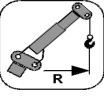
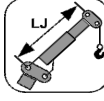
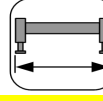
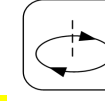
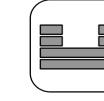
				
	JIB800.1HX	50%	360°	200 kg 440 lbs
	1,65	2,5	3,75	
	5,41	8,20	12,30	
2,0				
6,56				
3,0				
9,84				
4,0				
13,12				
5,0				
16,40				
6,0				
19,69				
7,0				
22,97				
8,0				
26,25				
9,0				
29,53				
9,7				
31,82				
10,7				
35,10				

SPX424 + JIB800.1MX

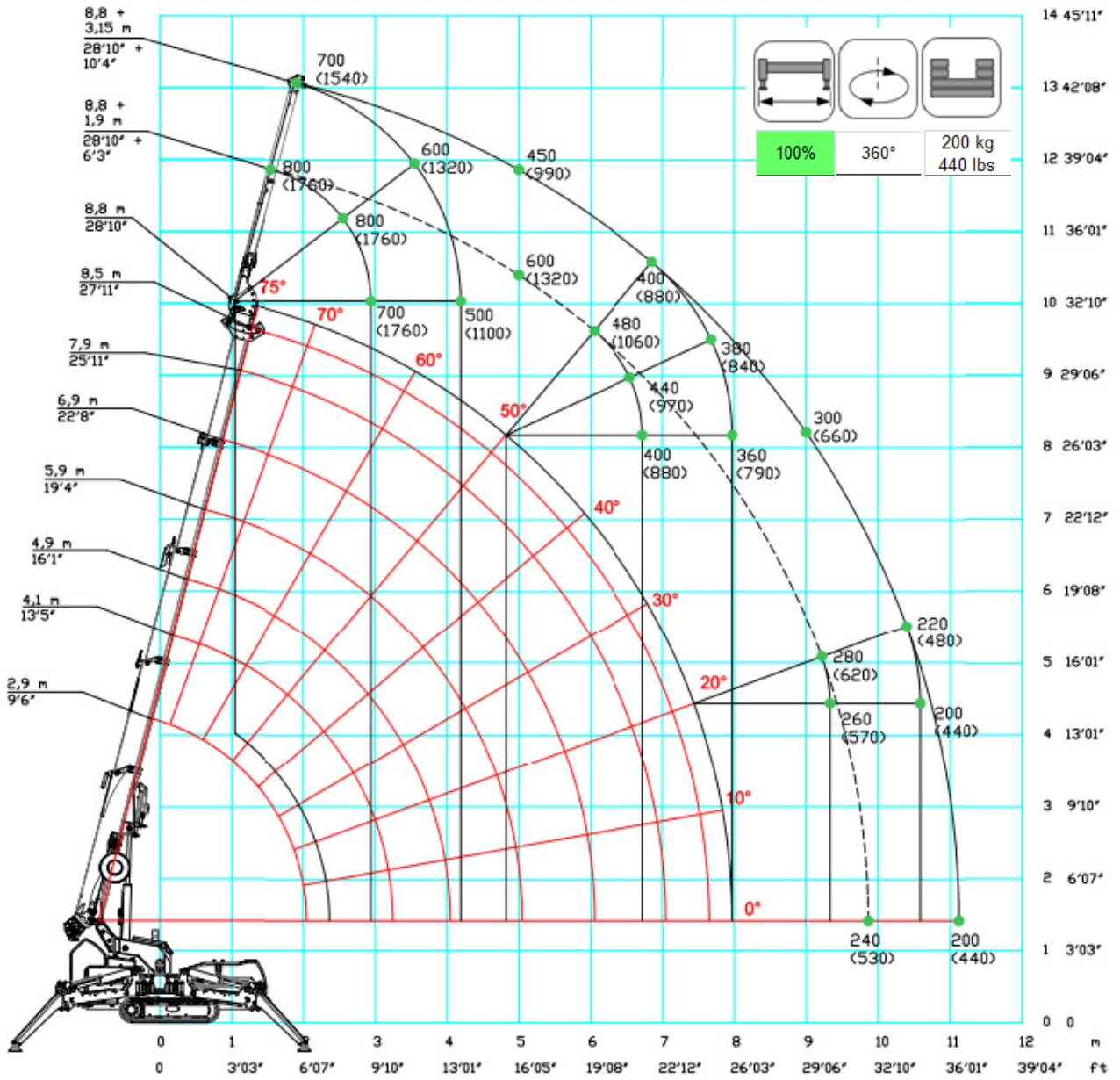

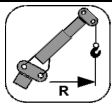
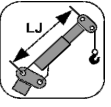
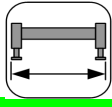
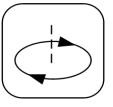
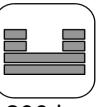
				
	JIB800.1MX	100%	360°	200 kg 440 lbs
	1,9	3,15		
	6,23	10,33		
2,0	800	700		
6,56	1760	1540		
3,0	700	600		
9,84	1540	1320		
4,0	600	500		
13,12	1320	1100		
5,0	600	450		
16,40	1320	990		
6,0	480	440		
19,69	1056	968		
7,0	440	400		
22,97	968	880		
8,0	380	360		
26,25	836	792		
9,0	320	300		
29,53	704	660		
10,0	240	240		
32,81	528	528		
11,0		200		
36,09		440		

kg/m
lbs/ft

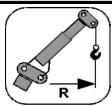
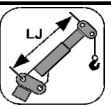
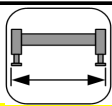
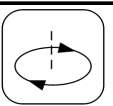
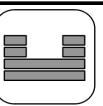
				
	JIB400.1MX	50%	330°	0 kg 0 lbs
	1,9	3,15		
	6,23	10,33		
2,0				
6,56				
3,0				
9,84				
4,0				
13,12				
5,0				
16,40				
6,0				
19,69				
7,0				
22,97				

JIB800GX

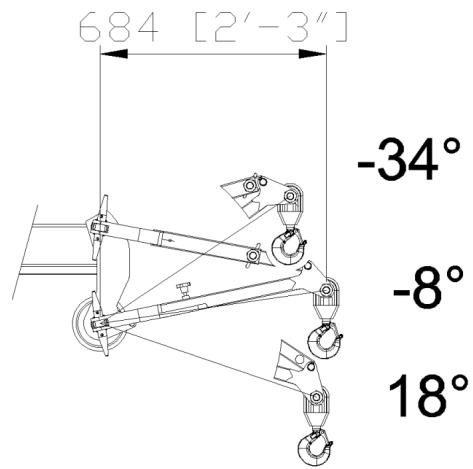

JIB800.1MX

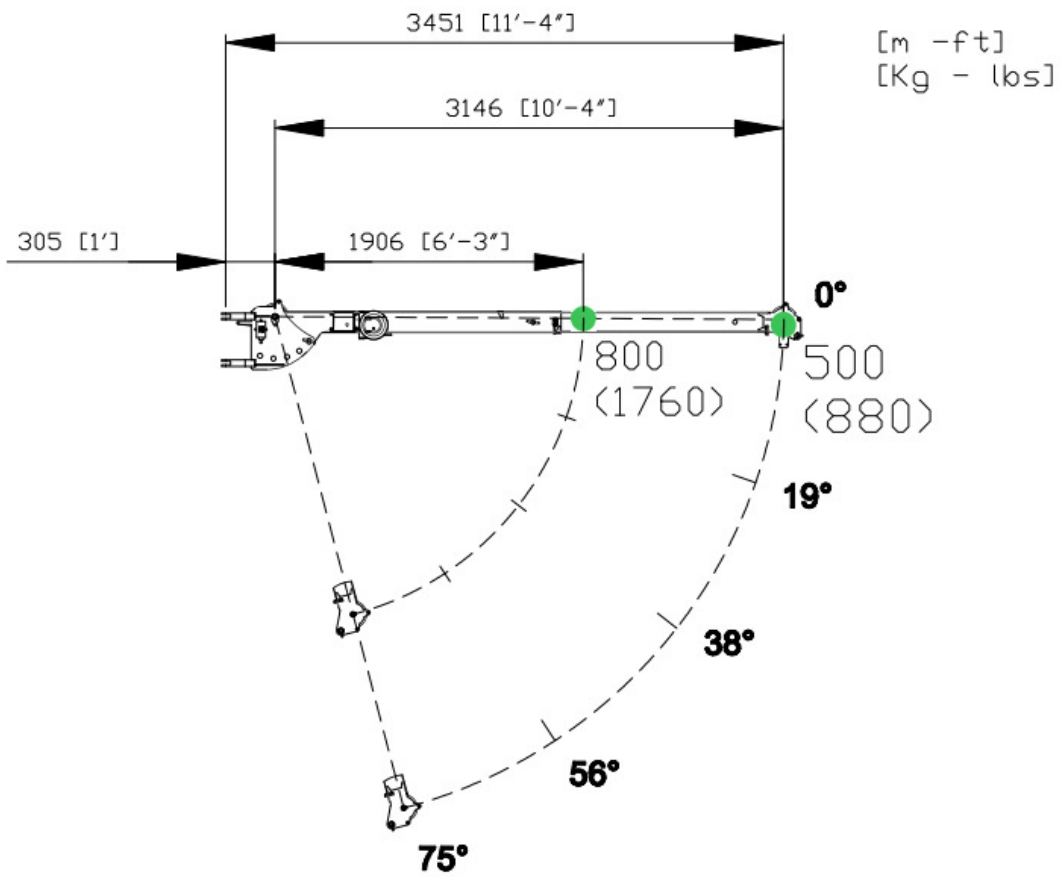

JIB800.1HX

[m -ft]
[Kg - lbs]

